



tune°

EINFACHHEIT IST DAS RESULTAT DER REIFE.

SIMPLICITY IS THE RESULT OF EXPERIENCE.

SCHILLER



Arbeitsfläche: 2x 160 x 80 cm
Oberfläche: kristallweiß / Kante schwarz
Gestell: kristallweiß struktur
Caddy und Schrank:
kristallweiß und apfelgrün

*Work stations: 2x 160 x 80 cm
Top: crystal white / black edge
Frame: crystal white structure
Caddy and cupboard:
crystal white and apple green*





tune°





Arbeitsische: 2x 160 x 80 cm

Oberfläche: kristallweiß / Kante schwarz

Gestell: kristallweiß struktur

Container, Caddy und Sideboard: kristallweiß

Work stations: 2x 160 x 80 cm

Top: crystal white / black edge

Frame: crystal white structure

Caddy, pedestals and sideboard: crystal white



Arbeitsfläche: 160 x 80 cm

Oberfläche: kristallweiß / Kante schwarz

Gestell: kristallweiß struktur

Caddies: kristallweiß

Work stations: 160 x 80 cm

Top: crystal white / black edge

Frame: crystal white structure

Caddies: crystal white



Arbeitsfläche: 160 x 80 cm

Oberfläche: kristallweiß / Kante schwarz

Gestell: kristallweiß struktur

Rückwand: transluzent

Container: kristallweiß

Work station: 160 x 80 cm

Top: crystal white / black edge

Frame: crystal white structure

Modesty panel: translucent

Pedestal: crystal white

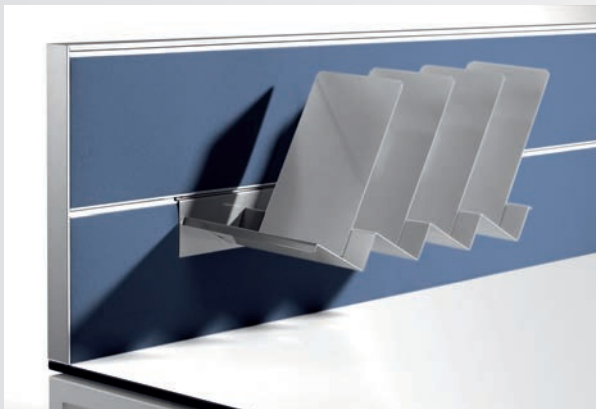

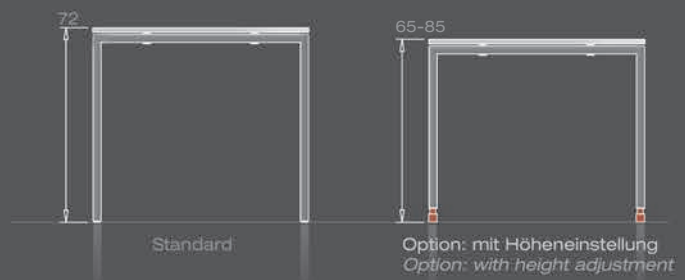
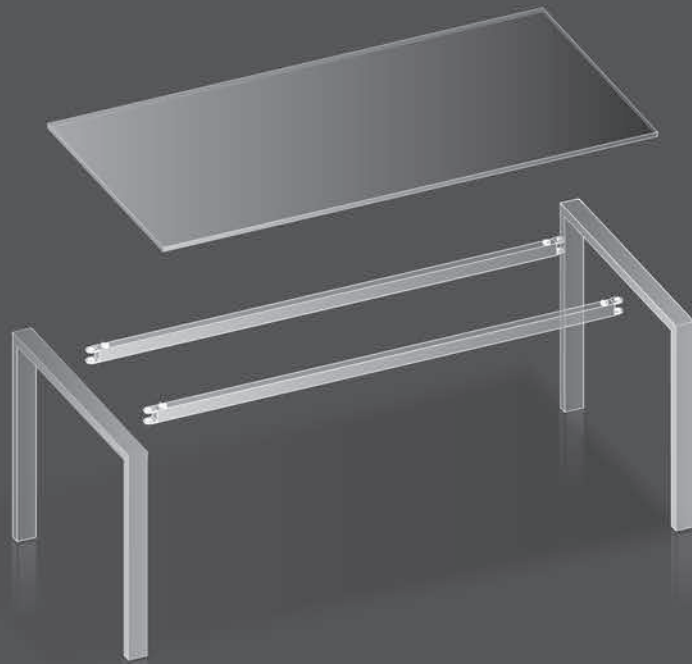

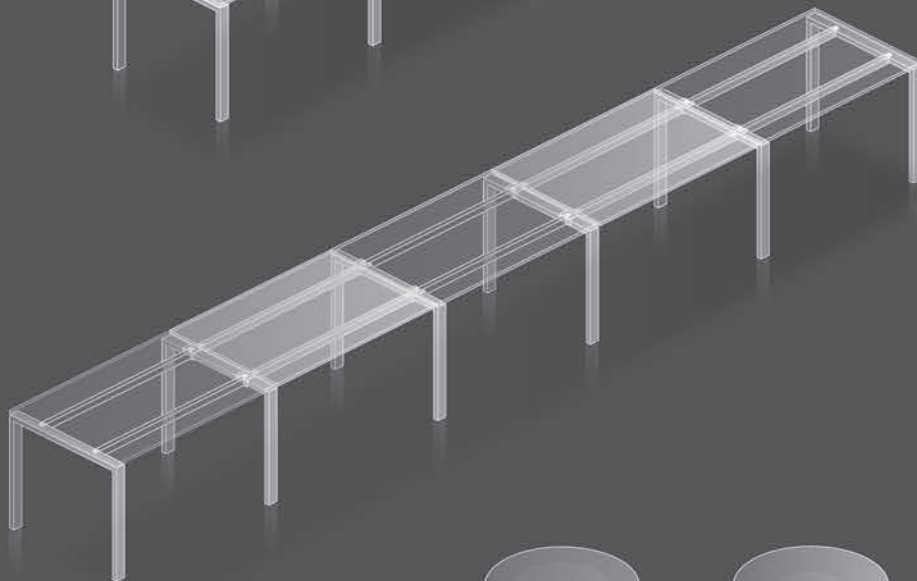
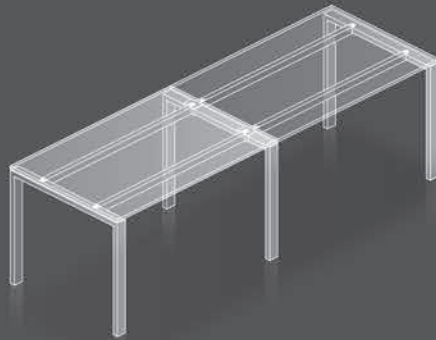
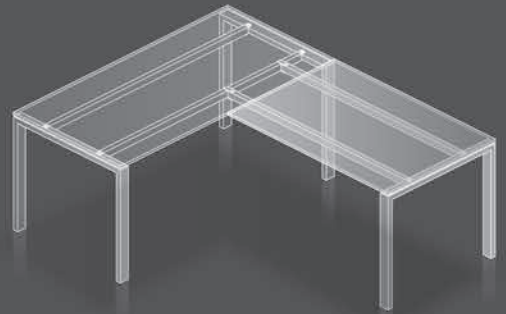
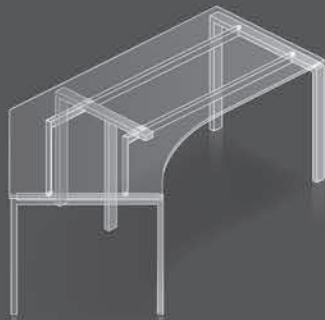

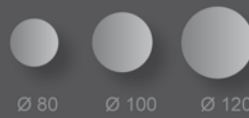
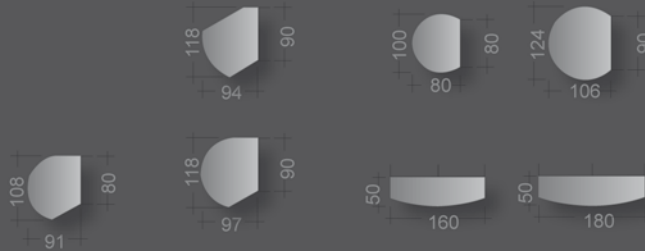
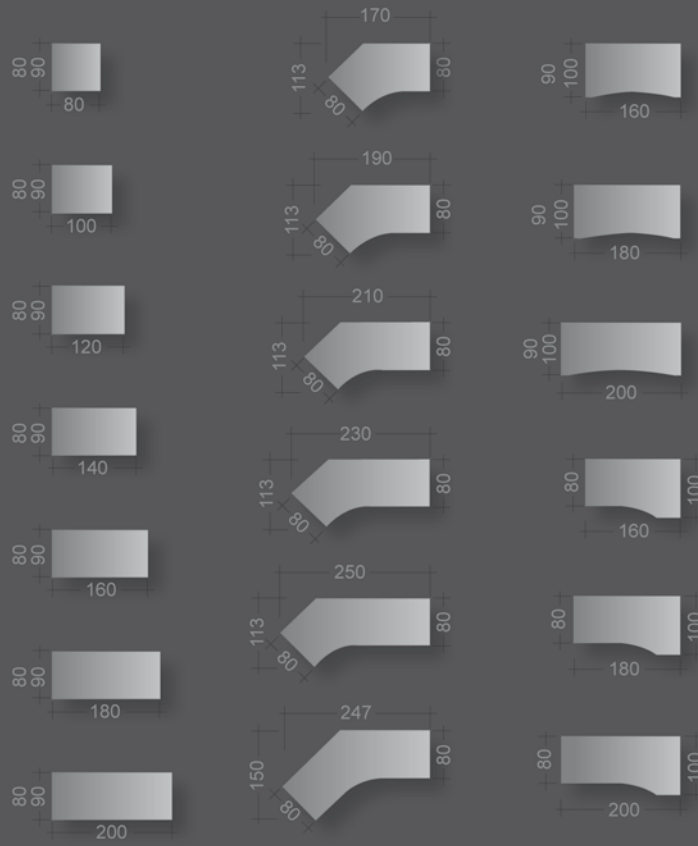

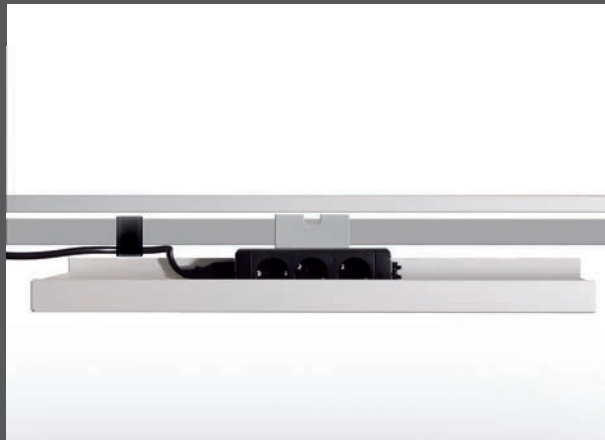
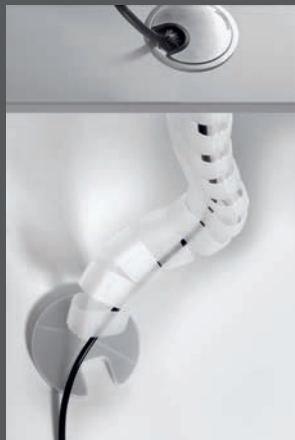
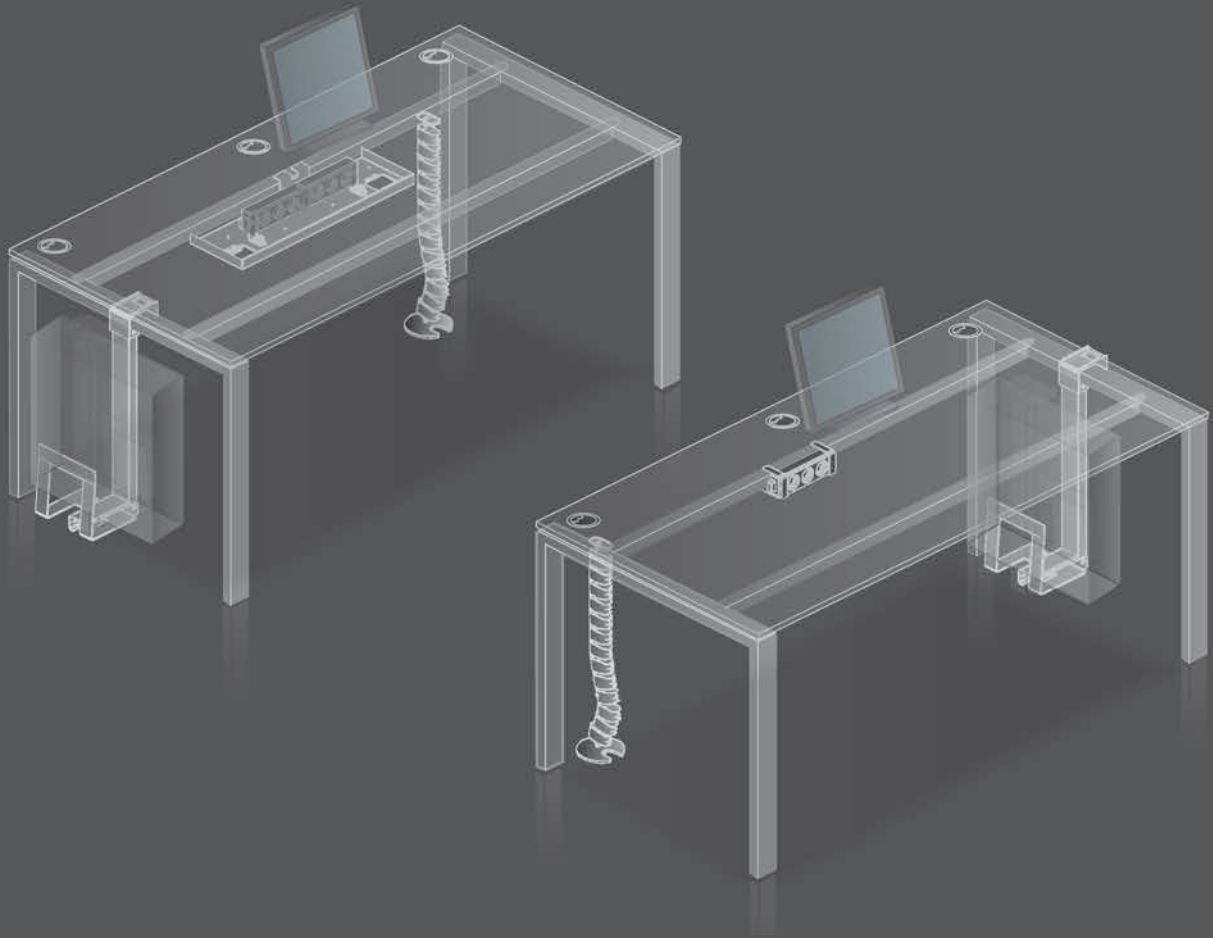

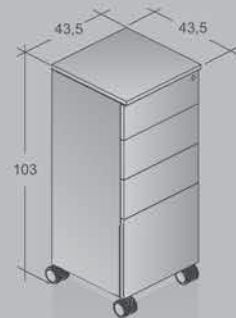
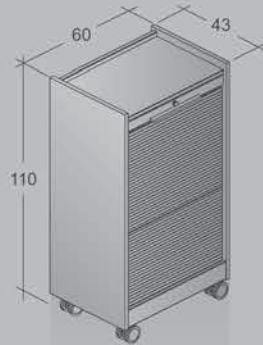
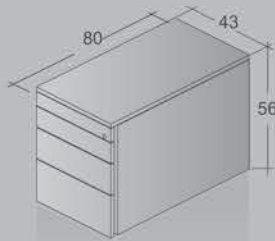
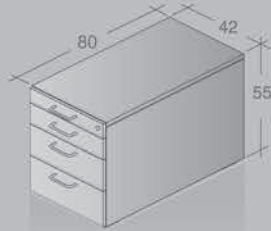





Arbeits-tisch: 160 x 80 cm

Oberfläche: kristallweiß / Kante schwarz

Gestell: kristallweiß struktur

Container: kristallweiß / orangerot

Work station: 160 x 80 cm

Top: crystal white / black edge

Frame: crystal white structure

Pedestal: crystal white / orange red

Arbeitsstisch: 230 x 113 cm

Oberfläche: kristallweiß

Gestell: helium

Container: kristallweiß



Work station: 230 x 113 cm

Top: crystal white

Frame: helium

Pedestal: crystal white



Arbeitsstisch: 200 x 80 cm / 120 x 80 cm

Oberfläche: kristallweiß

Gestell: kristallweiß struktur

Container: kristallweiß

Work station: 200 x 80 cm / 120 x 80 cm

Top: crystal white

Frame: crystal white structure

Pedestal: crystal white

Impressum:

Design tune: Michael Wirsing
Design Scube: André Vormdran

Konzept & Realisierung:
ehlers-media.com

Fotografie:
Rolf Nachbar (on location)
Thomas Oswald (Studio)
Gerd Heinlein (Details)
Some of the location
kindly provided by
Krick Verlag | Welt AG Eibelsdorf





Arbeitsfläche: 250 x 113 cm

Oberfläche: kristallweiß

Gestell: helium

Container und Sideboard:

kristallweiß

Work stations: 250 x 113 cm

Top: crystal white

Frame: helium

Pedestal and sideboard:

crystal white

LEUWICO GmbH

Hauptstraße 2-4
D - 96484 Wiesenfeld
Telefon +49 9566 88-0
Telefax +49 9566 88-114
E-Mail: info@leuwico.com
www.leuwico.com

Kontakt Österreich

LEUWICO
Büroeinrichtungen GmbH
Landwiedstraße 23
A-4020 Linz
Telefon +43 732 67 17 93-0
Telefax +43 732 67 43 57
E-Mail: office@leuwico.at
www.leuwico.at

Kontakt Schweiz

JOMA-Trading AG
Weiernstrasse 22
CH-8355 Aadorf
Telefon +41 52 36 54 111
Telefax +41 52 36 52 051
E-Mail: info@joma.ch
www.joma.ch

Contact details USA

EISYS, INC.
112 28th Street South
USA-Birmingham, AL 35233
Phone +1 205.941.1942
Fax +1 205.941.1781
email: info@eisis-inc.com
www.eisis-inc.com